

Guest Suite 1

GUEST SUITE 1
Level 2 Tower 1

GUEST SUITE SPACE, 1 BATH, TERRACE



INTERIOR	317 SQ.FT.	29.46M ²
TERRACE	108 SQ.FT.	10.04M ²
TOTAL	425 SQ.FT.	39.50M²

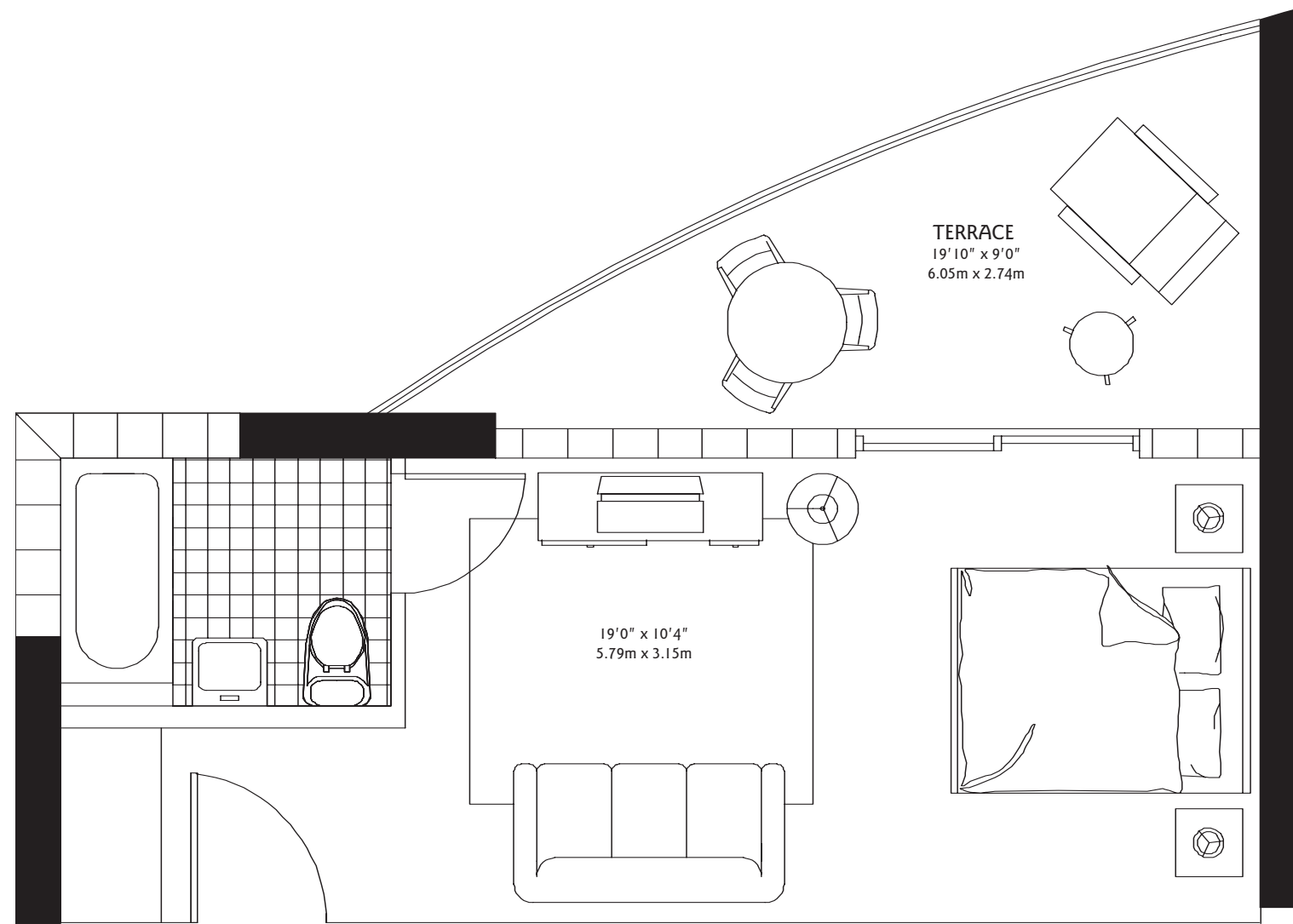

The Parc At Turnberry Isle

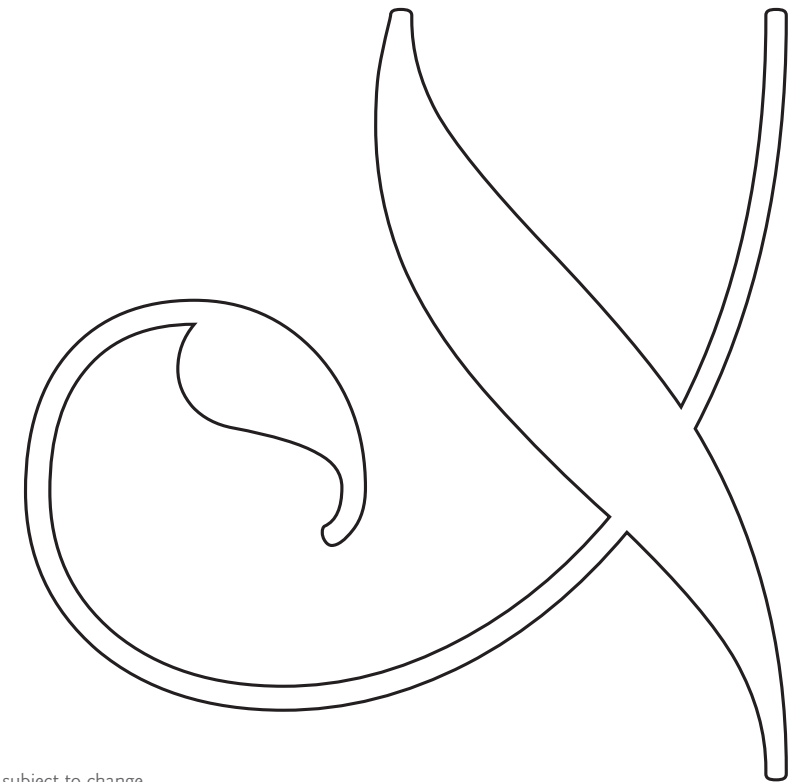

Stated dimensions are measured to the exterior boundaries of the exterior walls and the center line of interior demising walls. All dimensions are approximate and all floor plans and development plans are subject to change.

Guest Suite 2

GUEST SUITE 2 Level 2 Tower 1

GUEST SUITE SPACE, 1 BATH

INTERIOR	329 SQ.FT.	30.58M ²
TOTAL	329 SQ.FT.	30.58M ²



At Turnberry Isle

The Parc

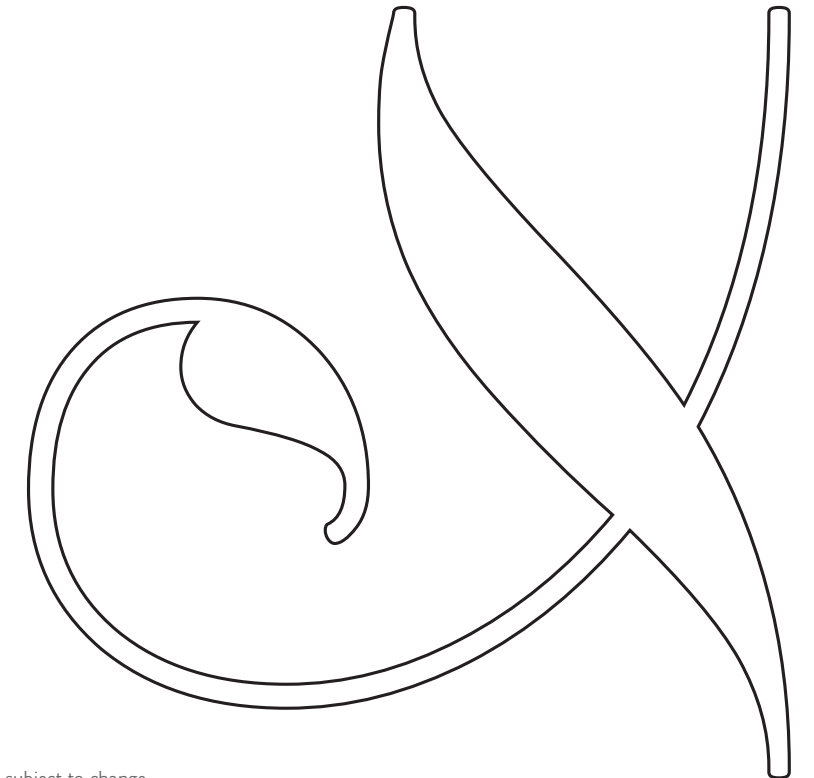
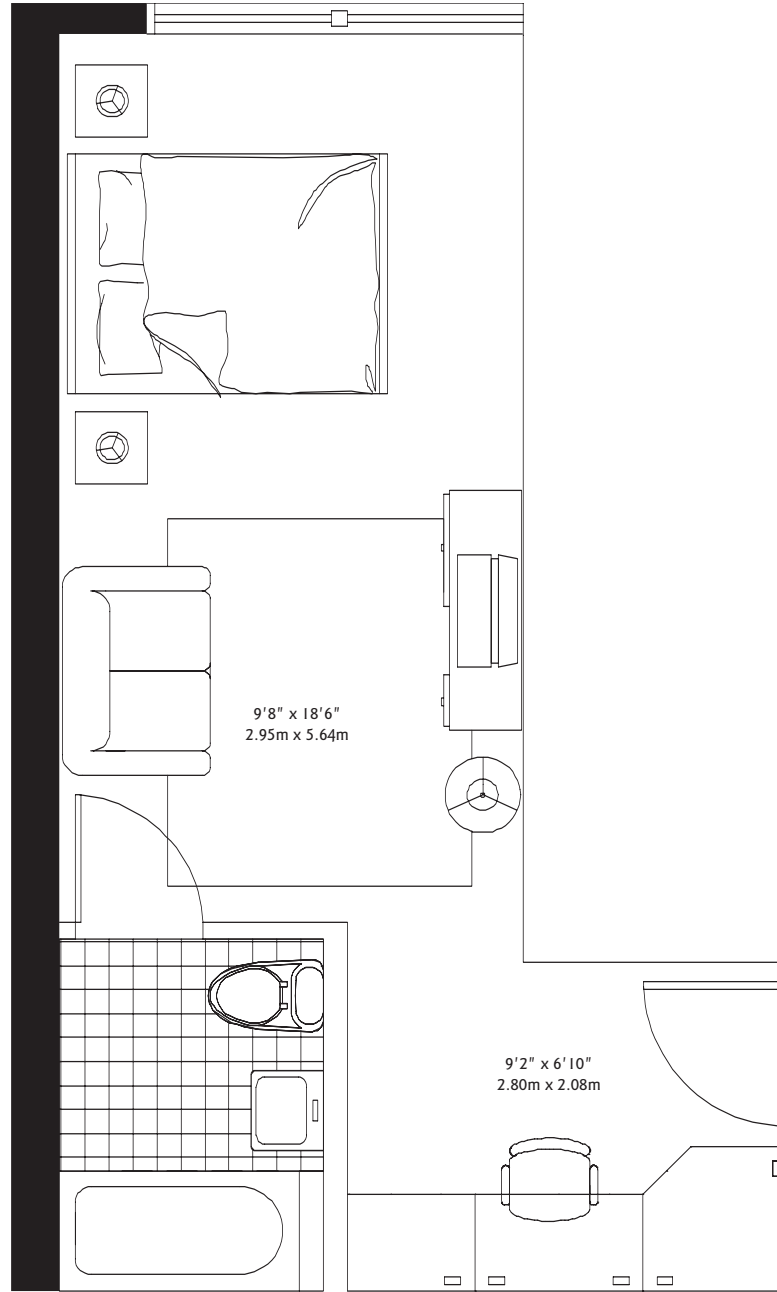

Stated dimensions are measured to the exterior boundaries of the exterior walls and the center line of interior demising walls. All dimensions are approximate and all floor plans and development plans are subject to change.

Guest Suite 3

GUEST SUITE 3
Level 2 Tower 1

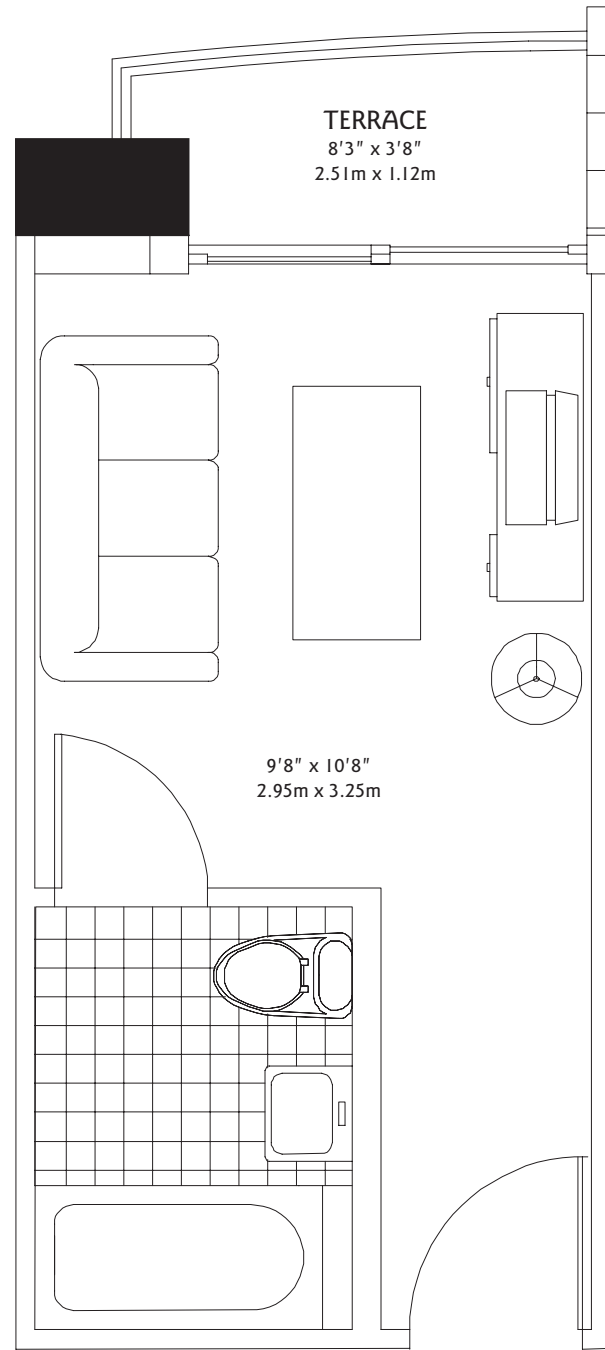

GUEST SUITE SPACE, 1 BATH, TERRACE

INTERIOR	195 SQ.FT.	18.12M ²
TERRACE	27 SQ.FT.	2.51M ²
TOTAL	222 SQ.FT.	20.63M²



At Turnberry Isle

The Parc

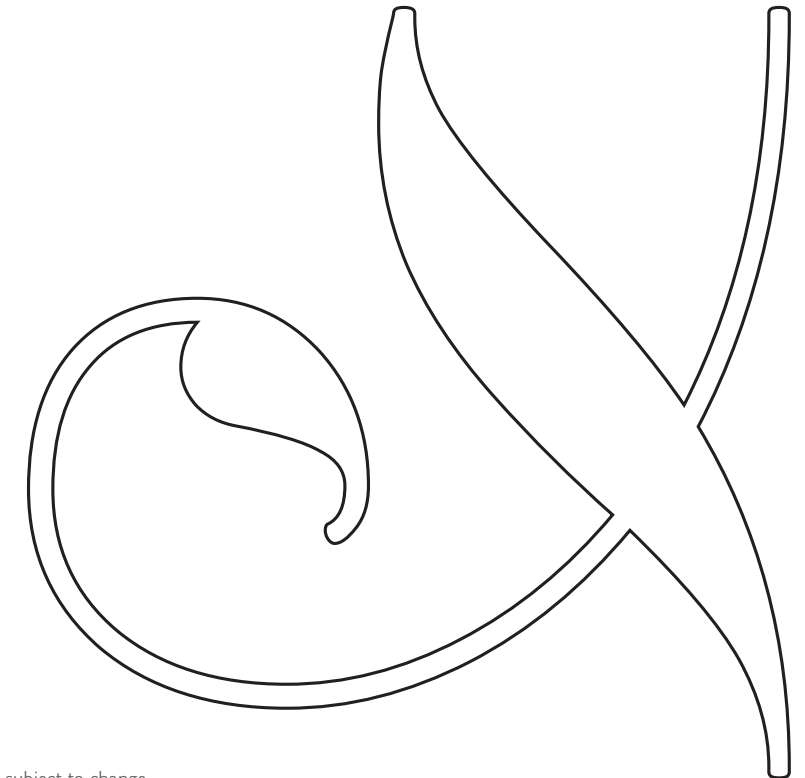

Stated dimensions are measured to the exterior boundaries of the exterior walls and the center line of interior demising walls. All dimensions are approximate and all floor plans and development plans are subject to change.

Guest Suite 4

GUEST SUITE 4
Level 2 Tower 1

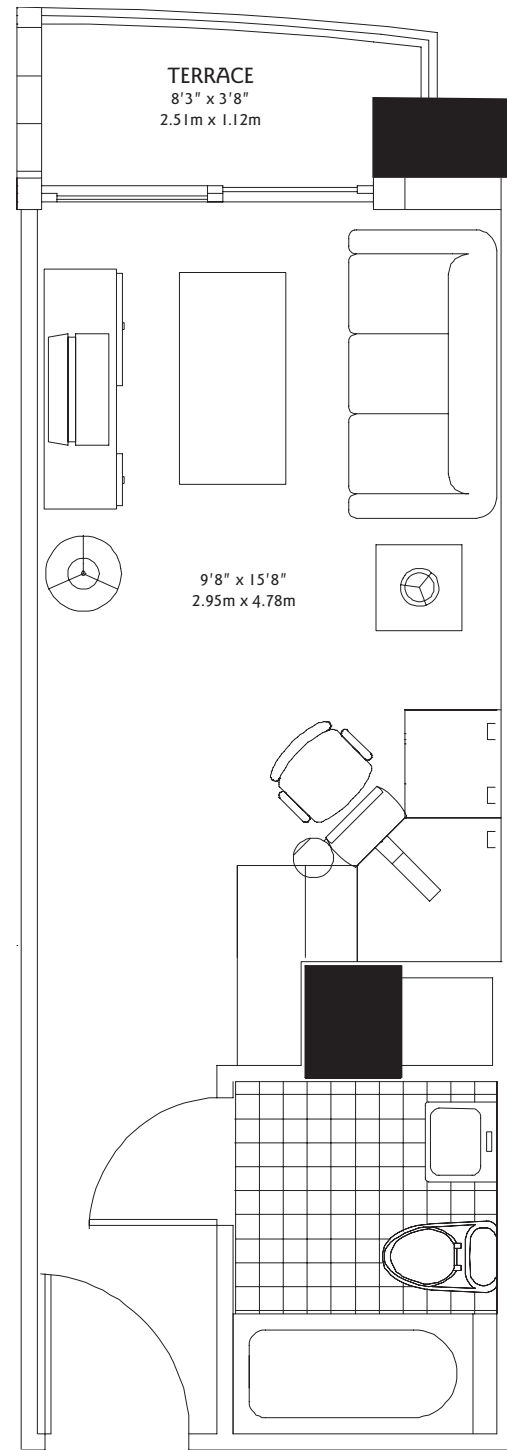

GUEST SUITE SPACE, 1 BATH, TERRACE

INTERIOR	257 SQ.FT.	23.88M ²
TERRACE	27 SQ.FT.	2.5 M ²
TOTAL	284 SQ.FT.	26.40 M²



At Turnberry Isle

The Parc

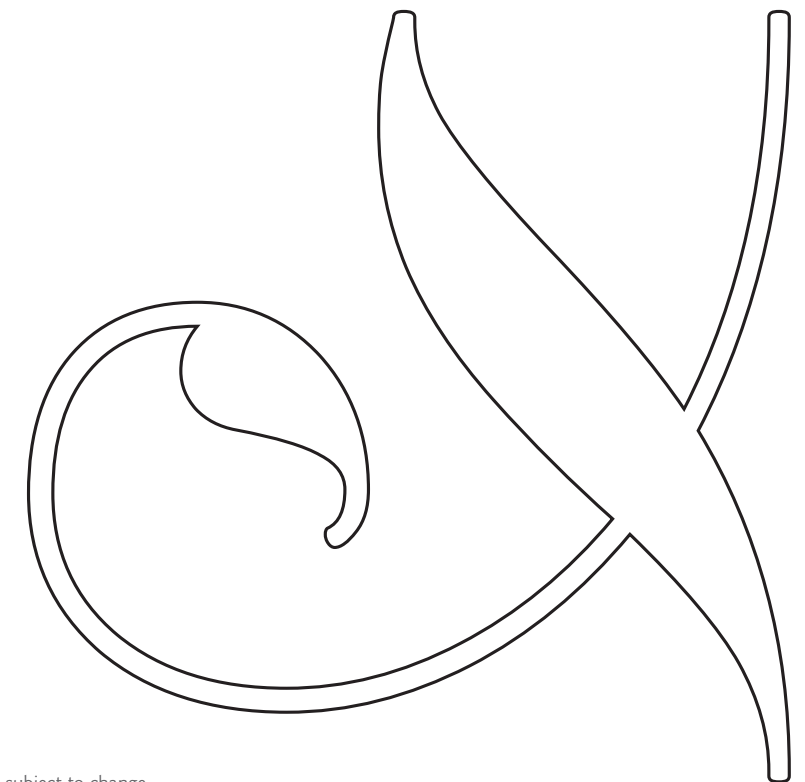

Stated dimensions are measured to the exterior boundaries of the exterior walls and the center line of interior demising walls. All dimensions are approximate and all floor plans and development plans are subject to change.

Guest Suite 5

GUEST SUITE 5 Level 2 Tower 1

GUEST SUITE SPACE, 1 BATH

INTERIOR	290 SQ.FT.	26.95 M ²
TOTAL	290 SQ.FT.	26.95 M ²



At Turnberry Isle

 *The Parc*

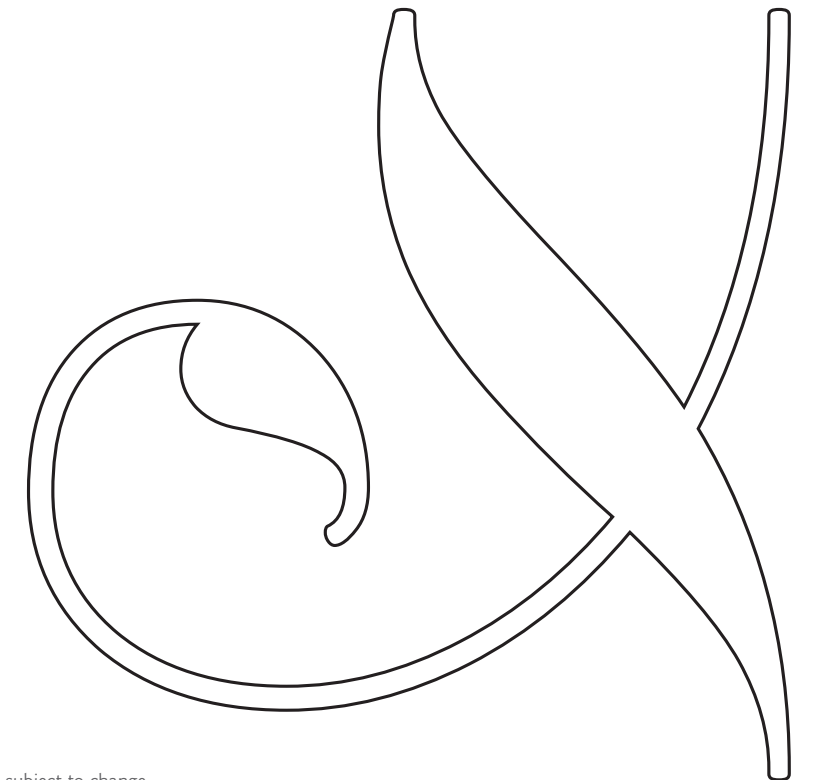
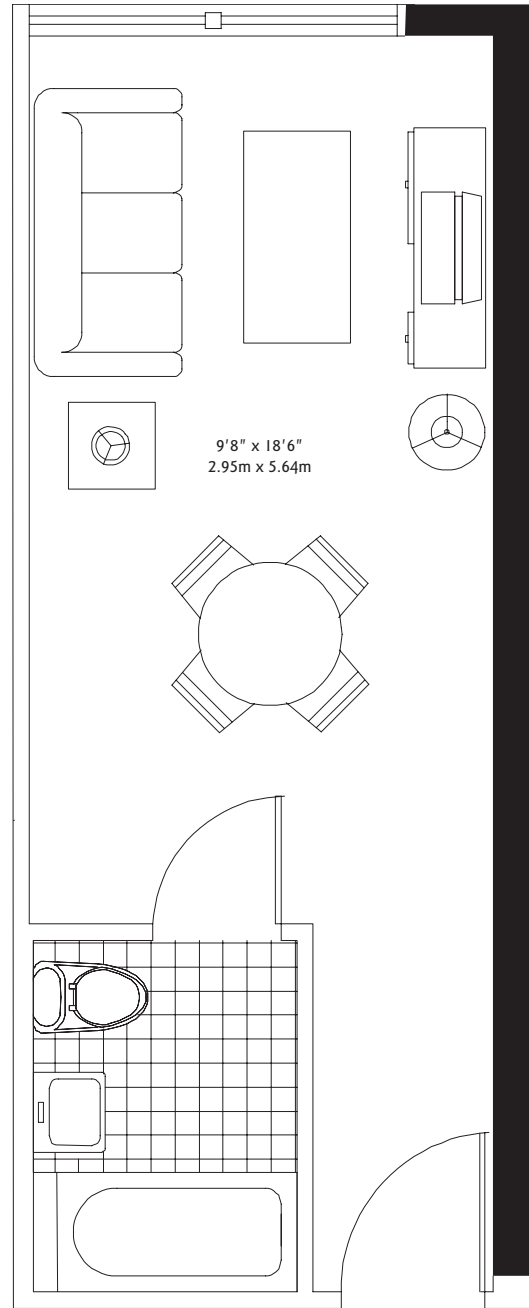

Guest Suite 6

GUEST SUITE 6
Level 2 Tower 1

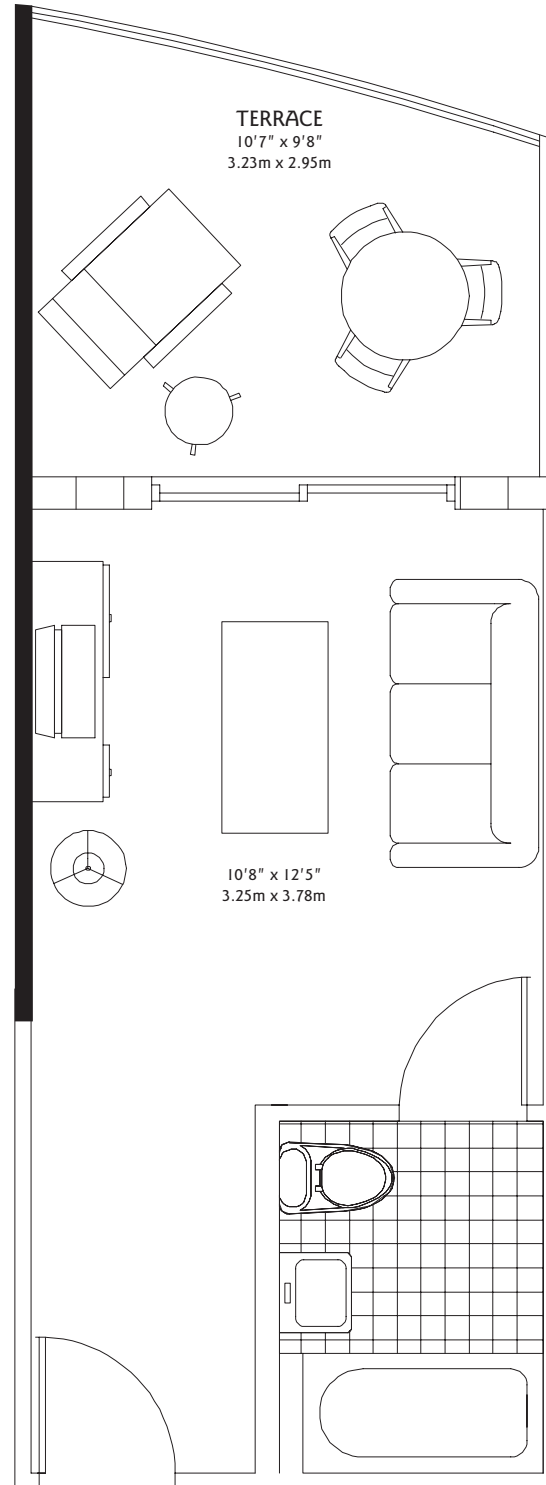

GUEST SUITE SPACE, 1 BATH, TERRACE

INTERIOR	235 SQ.FT.	21.84M ²
TERRACE	93 SQ.FT.	8.64 M ²
TOTAL	328 SQ.FT.	30.48 M²



The Parc At Turnberry Isle

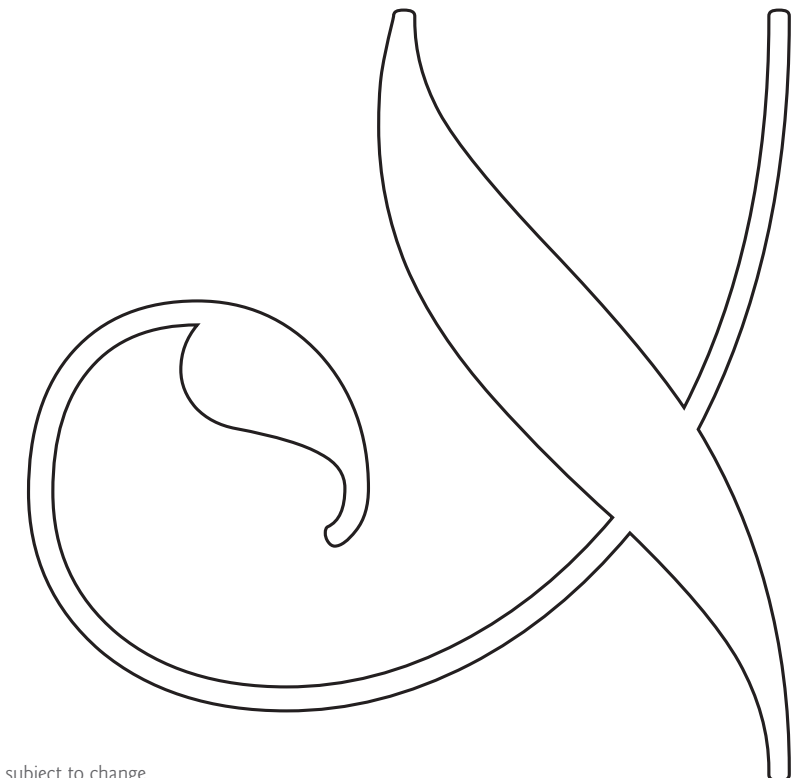

Stated dimensions are measured to the exterior boundaries of the exterior walls and the center line of interior demising walls. All dimensions are approximate and all floor plans and development plans are subject to change.

Guest Suite 7

GUEST SUITE 7
Level 2 Tower 1

GUEST SUITE SPACE, 1 BATH, TERRACE

INTERIOR	212 SQ.FT.	19.70 M ²
TERRACE	58 SQ.FT.	5.39 M ²
TOTAL	270 SQ.FT.	25.09 M²



At Turnberry Isle

The Parc

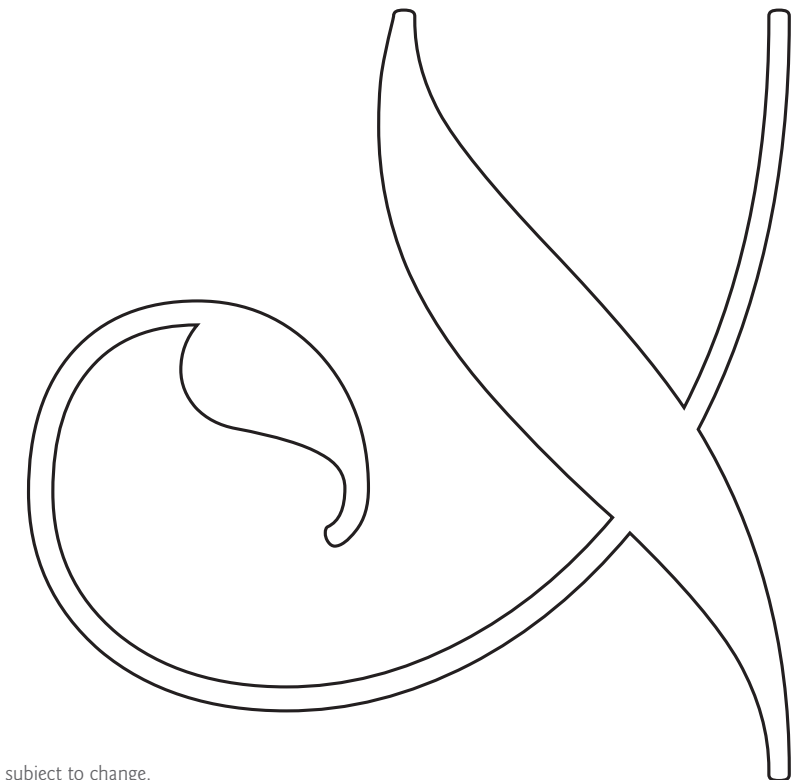
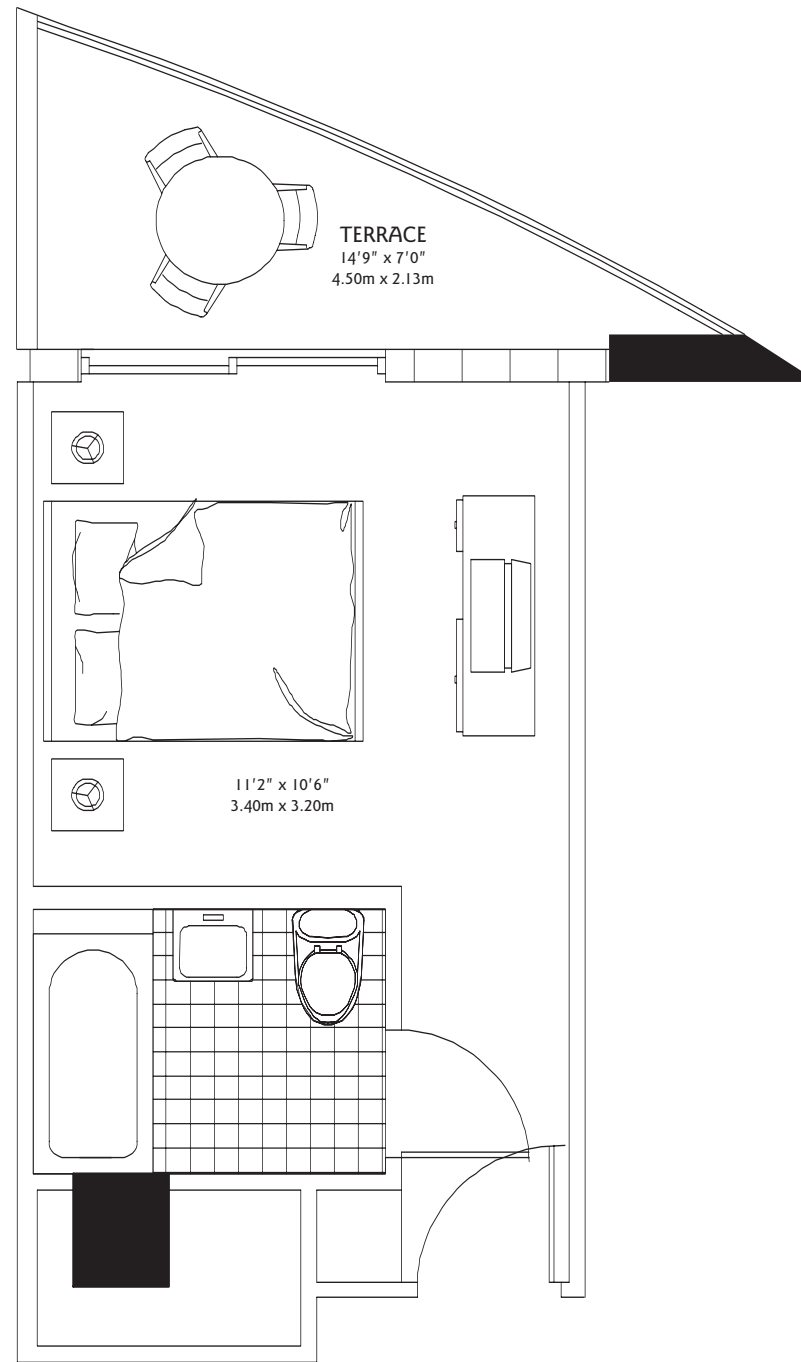

Stated dimensions are measured to the exterior boundaries of the exterior walls and the center line of interior demising walls. All dimensions are approximate and all floor plans and development plans are subject to change.

Guest Suite 8

GUEST SUITE 8
Level 2 Tower 1

GUEST SUITE SPACE, 1 BATH, TERRACE

INTERIOR	329 SQ.FT.	30.57 M ²
TERRACE	39 SQ.FT.	3.62 M ²
TOTAL	368 SQ.FT.	34.20 M²



At Turnberry Isle

The Parc

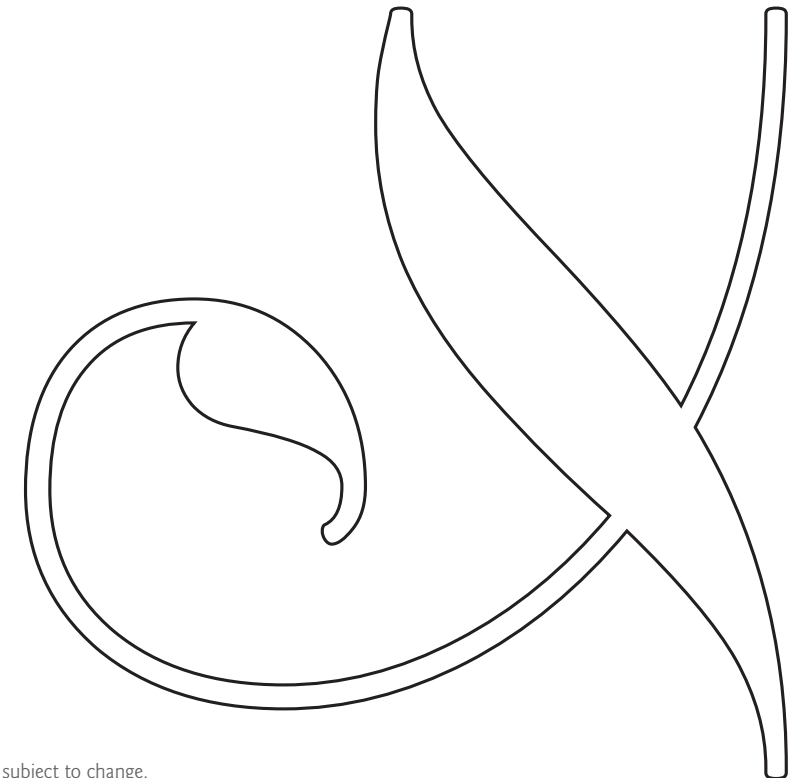
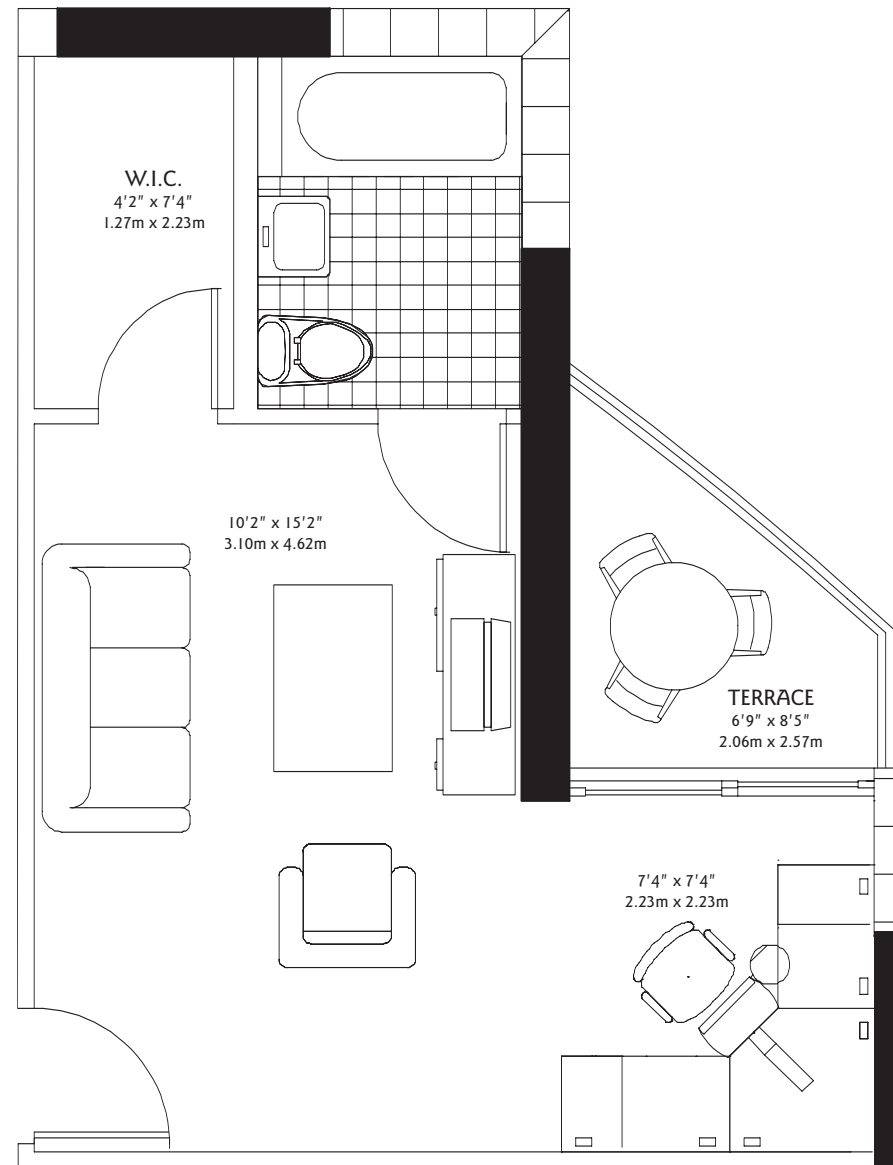

Stated dimensions are measured to the exterior boundaries of the exterior walls and the center line of interior demising walls. All dimensions are approximate and all floor plans and development plans are subject to change.

Guest Suite 9

GUEST SUITE 9
Level 2 Tower 1

GUEST SUITE SPACE, 1 BATH, TERRACE

INTERIOR	320 SQ.FT.	29.74 M ²
TERRACE	47 SQ.FT.	4.36 M ²
TOTAL	367 SQ.FT.	34.10 M²



At Turnberry Isle

The Parc

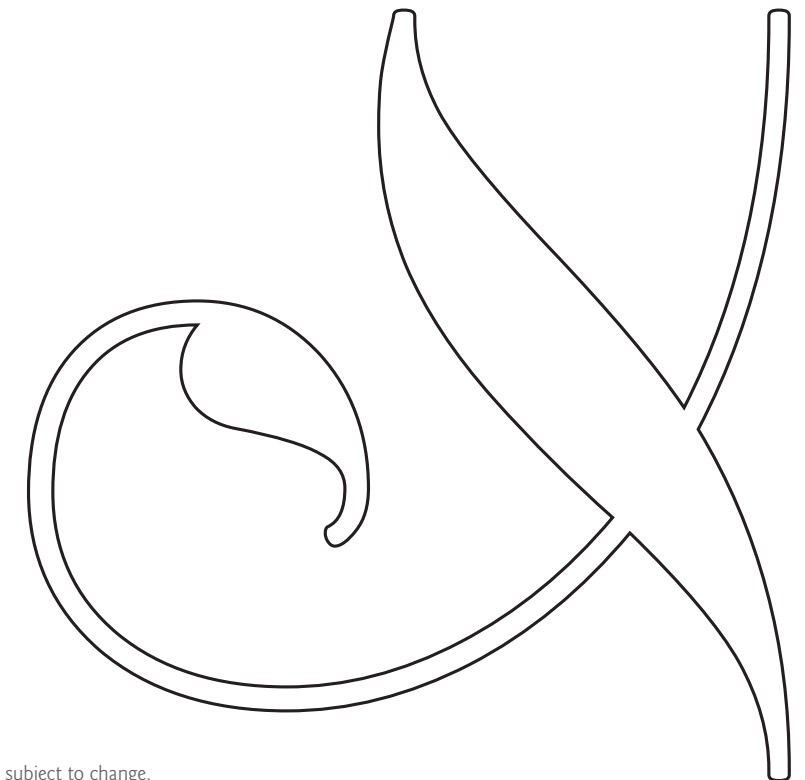
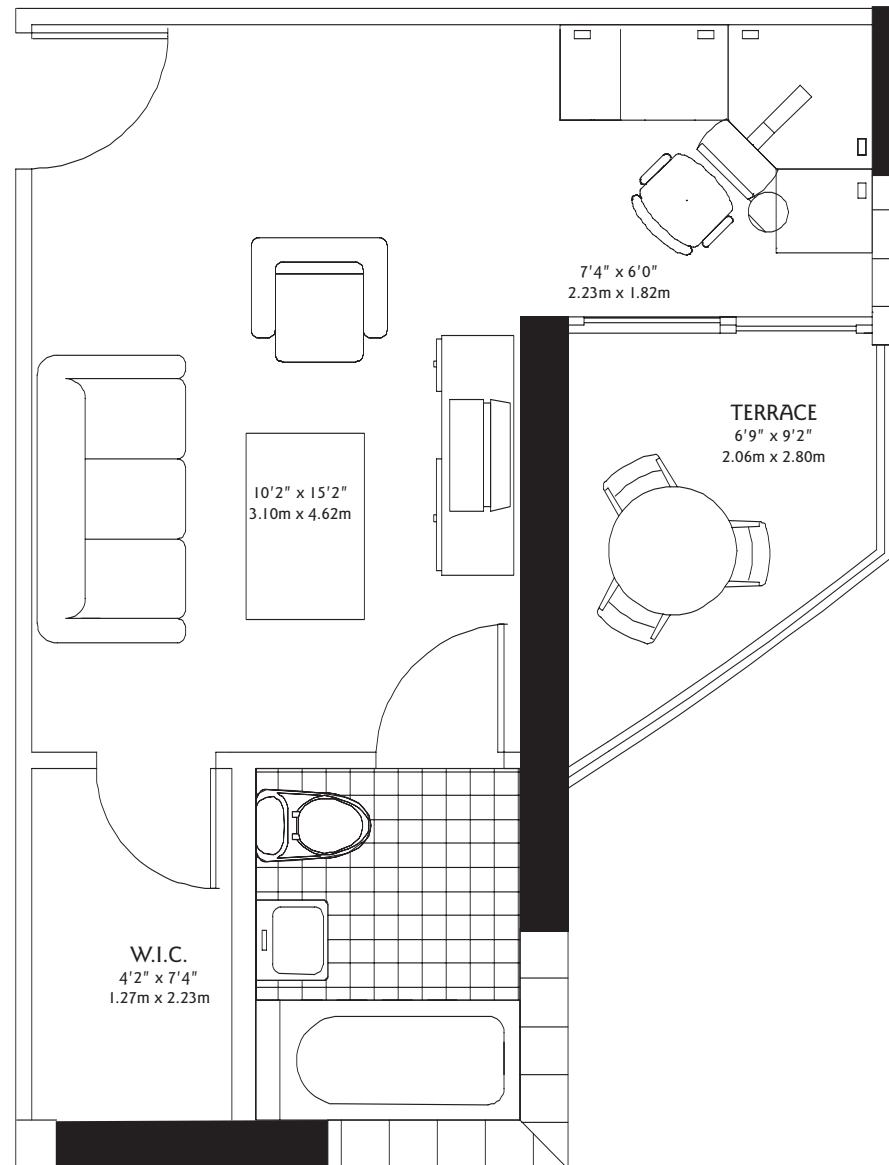

Stated dimensions are measured to the exterior boundaries of the exterior walls and the center line of interior demising walls. All dimensions are approximate and all floor plans and development plans are subject to change.

Guest Suite 10

GUEST SUITE 10
Level 2 Tower 1

GUEST SUITE SPACE, 1 BATH, TERRACE

INTERIOR	239 SQ.FT.	22.21 M ²
TERRACE	23 SQ.FT.	2.13 M ²
TOTAL	262 SQ.FT.	24.35 M²



The Parc At Turnberry Isle

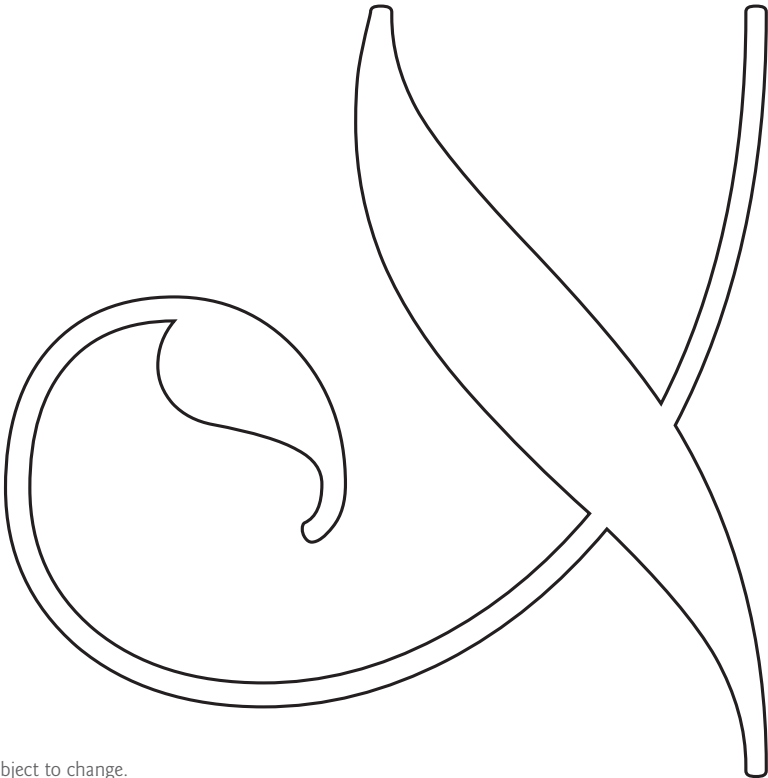
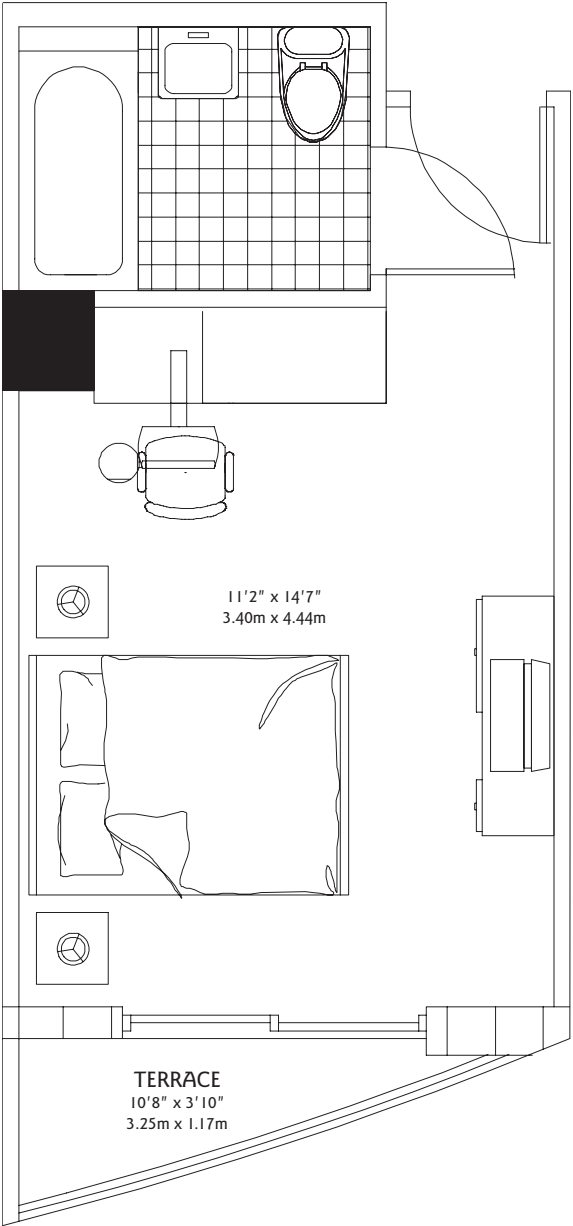

Stated dimensions are measured to the exterior boundaries of the exterior walls and the center line of interior demising walls. All dimensions are approximate and all floor plans and development plans are subject to change.

Guest Suite 11

GUEST SUITE 11
Level 2 Tower 1

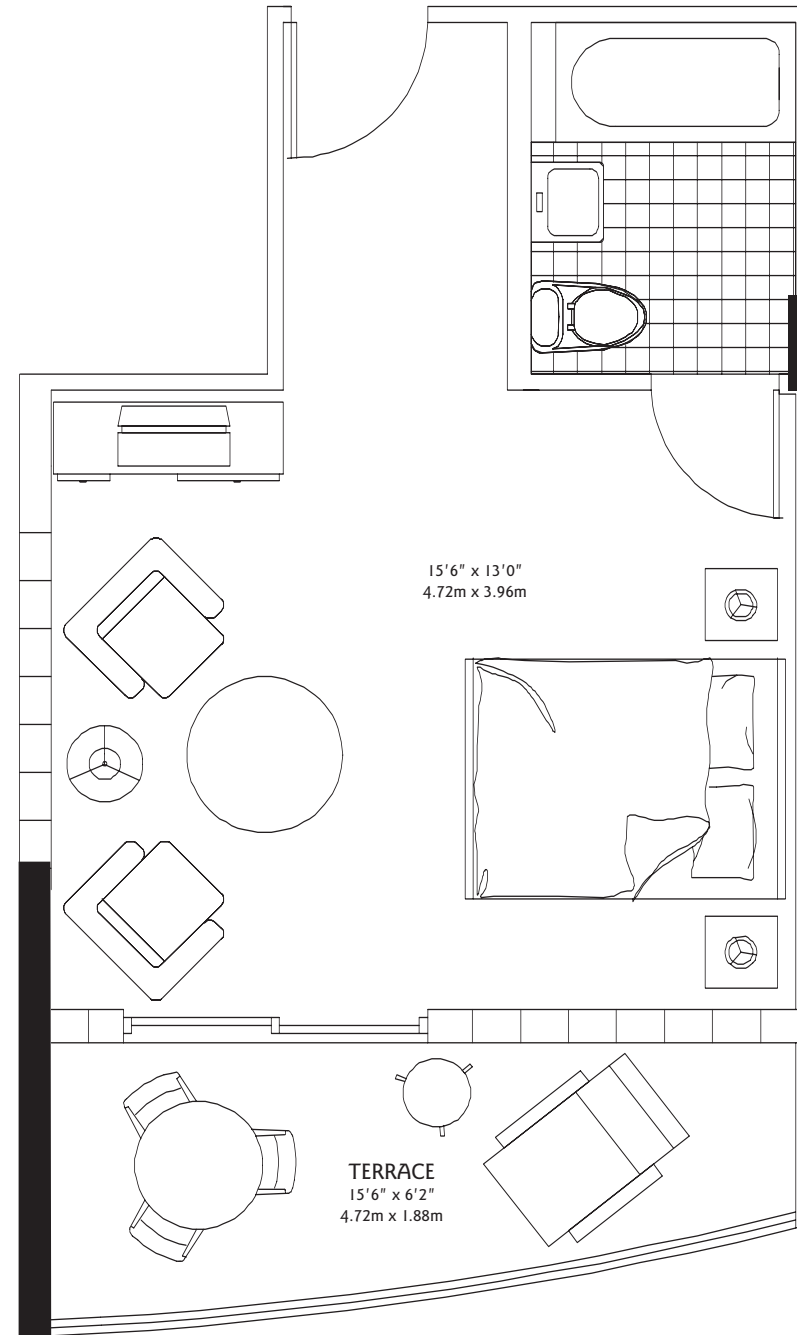

GUEST SUITE SPACE, 1 BATH, TERRACE

INTERIOR	301 SQ.FT.	27.97 M ²
TERRACE	81 SQ.FT.	7.53 M ²
TOTAL	382 SQ.FT.	35.50 M²



At Turnberry Isle

The Parc

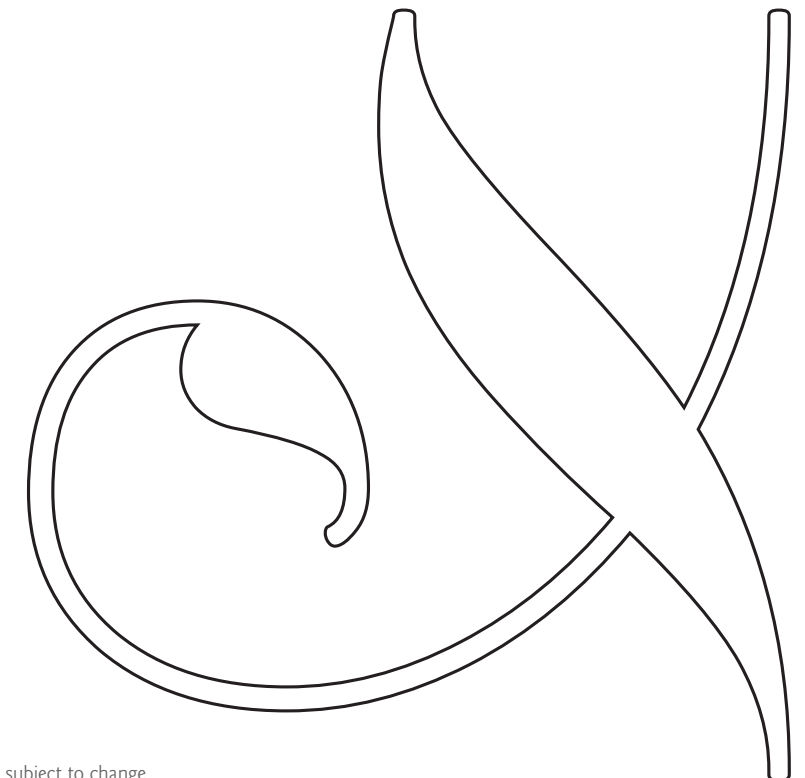

Stated dimensions are measured to the exterior boundaries of the exterior walls and the center line of interior demising walls. All dimensions are approximate and all floor plans and development plans are subject to change.

Guest Suite 12

GUEST SUITE 12
Level 2 Tower 1

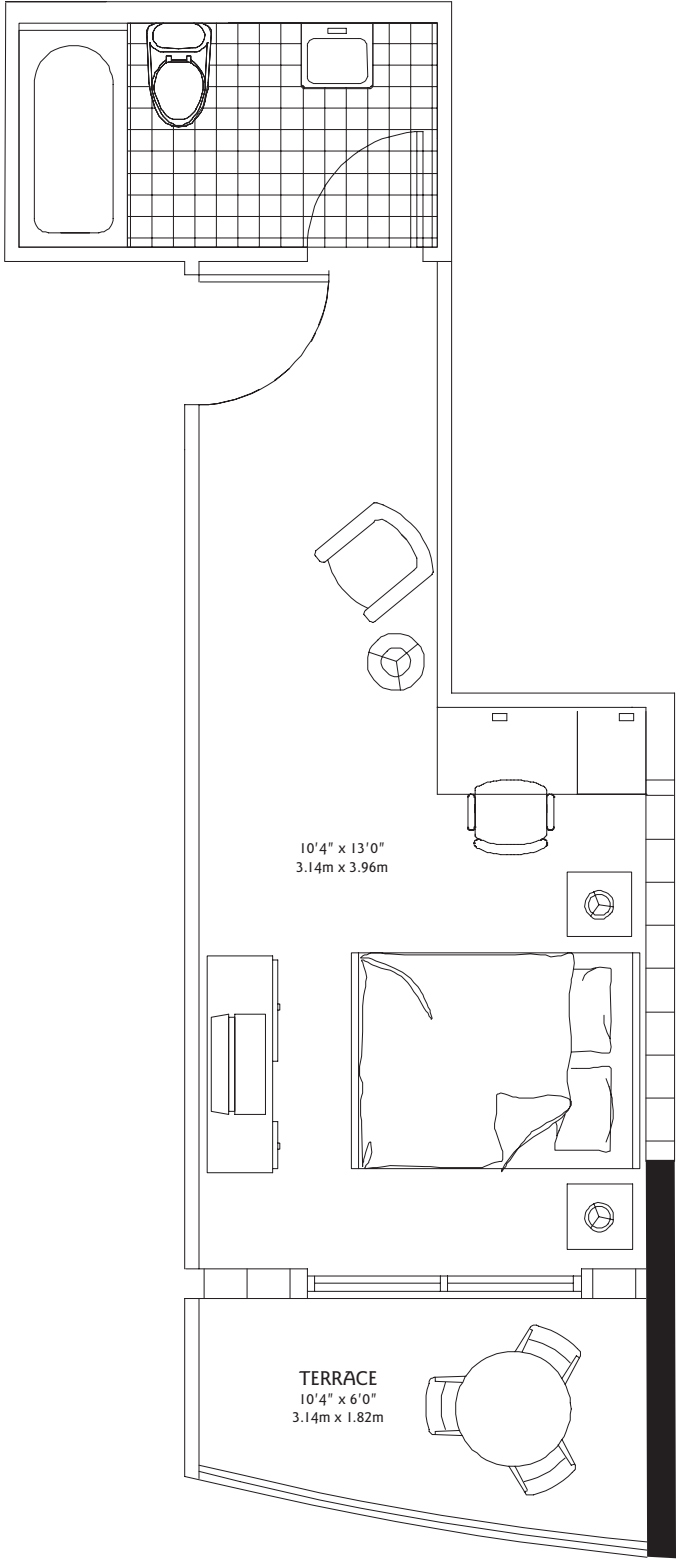

GUEST SUITE SPACE, 1 BATH, TERRACE

INTERIOR	260 SQ.FT.	24.16 M ²
TERRACE	54 SQ.FT.	5.01 M ²
TOTAL	314 SQ.FT.	29.17 M²



The Parc At Turnberry Isle

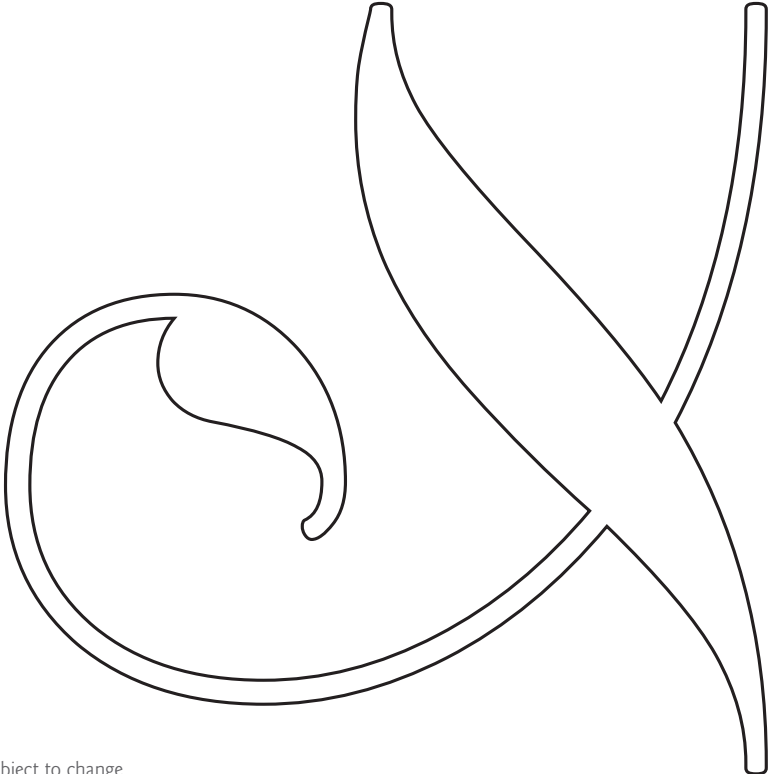

Stated dimensions are measured to the exterior boundaries of the exterior walls and the center line of interior demising walls. All dimensions are approximate and all floor plans and development plans are subject to change.

Guest Suite 13

GUEST SUITE 13
Level 2 Tower 1

GUEST SUITE SPACE, 1 BATH, TERRACE

INTERIOR	209 SQ.FT.	19.42 M ²
TERRACE	25 SQ.FT.	2.32 M ²
TOTAL	234 SQ.FT.	21.75 M²



At Turnberry Isle

The Parc

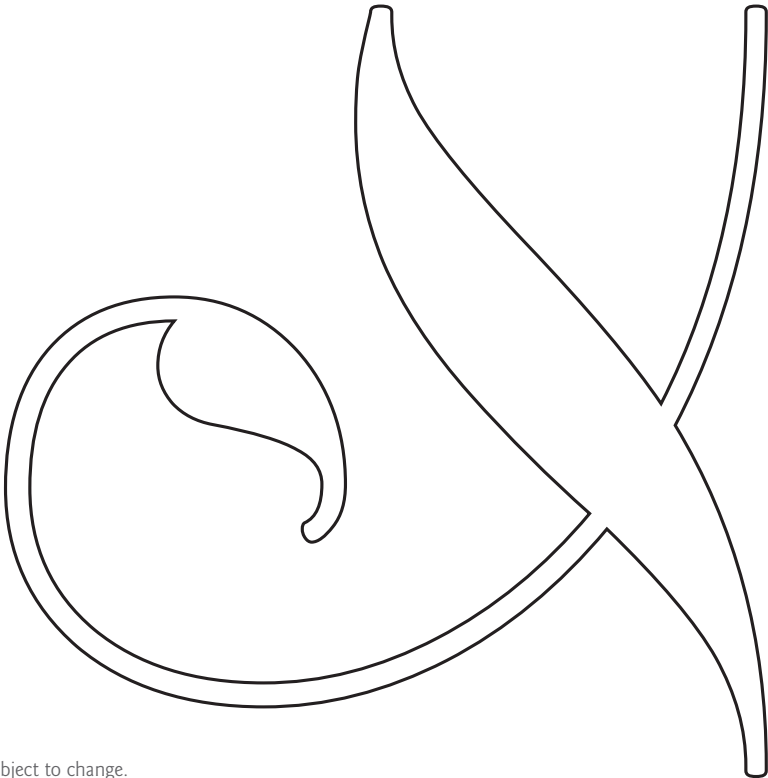
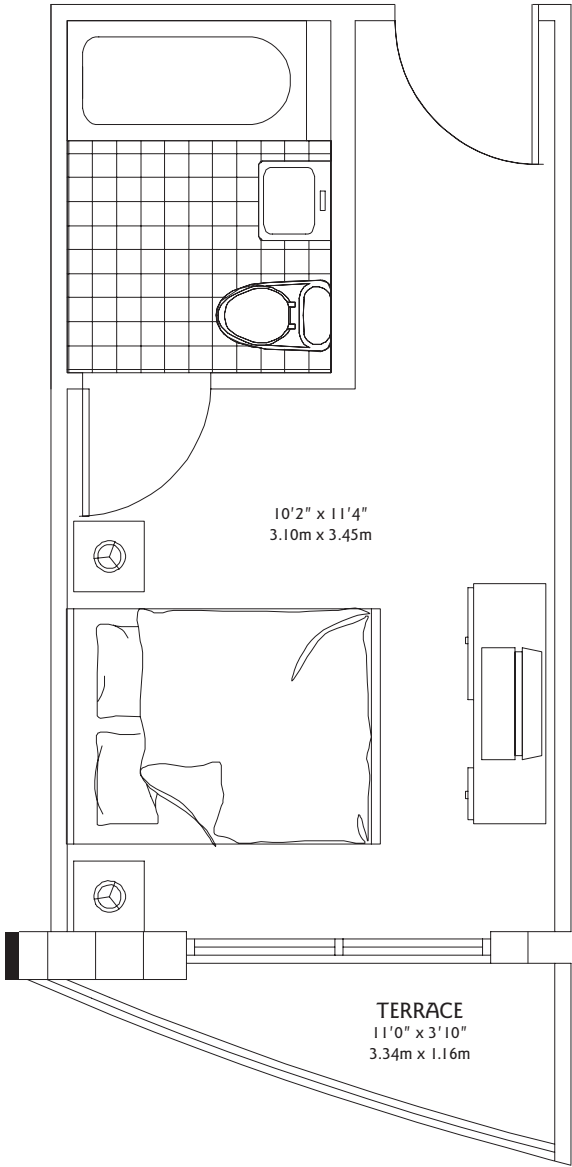

Stated dimensions are measured to the exterior boundaries of the exterior walls and the center line of interior demising walls. All dimensions are approximate and all floor plans and development plans are subject to change.

Guest Suite 14

GUEST SUITE 14 Level 2 Tower 1

GUEST SUITE SPACE, 1 BATH

INTERIOR	326 SQ.FT.	30.30 M ²
TOTAL	326 SQ.FT.	30.30 M ²



At Turnberry Isle

The Parc

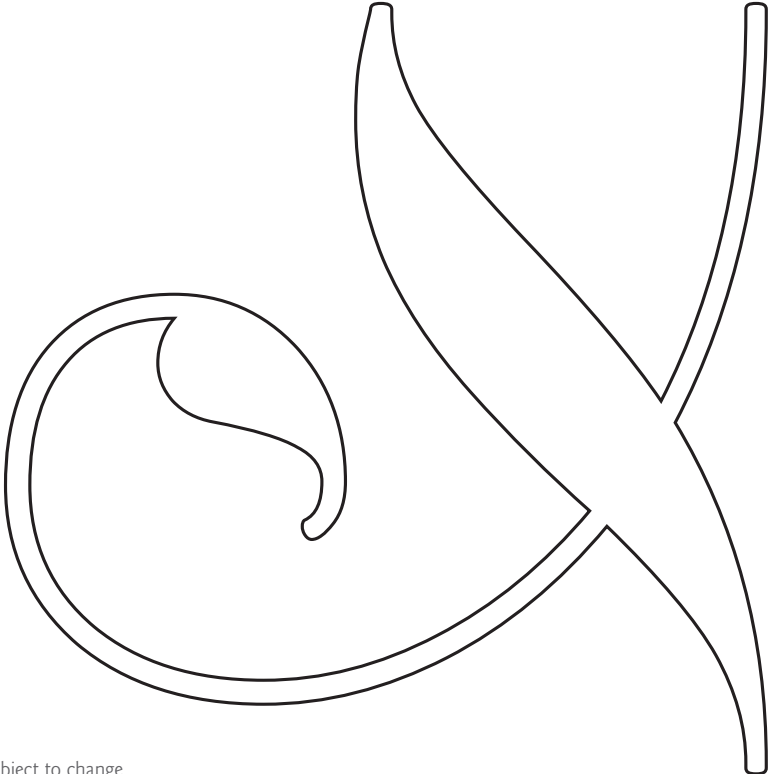
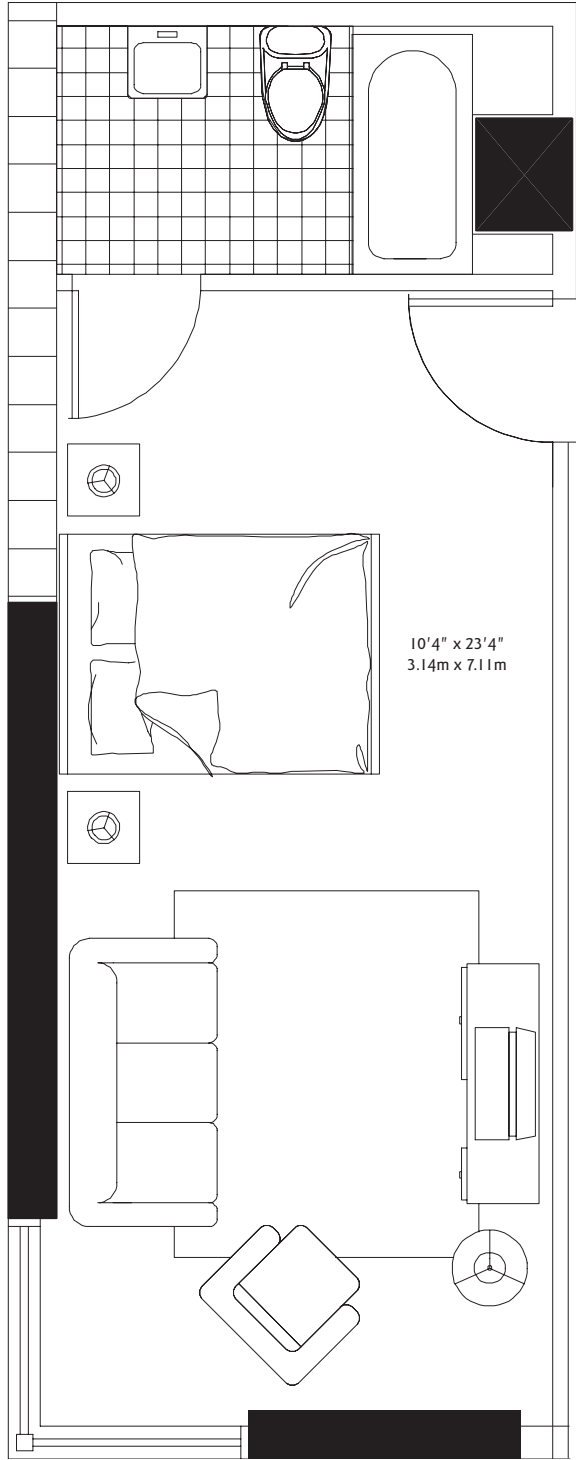

Stated dimensions are measured to the exterior boundaries of the exterior walls and the center line of interior demising walls. All dimensions are approximate and all floor plans and development plans are subject to change.